

END VIEWS / DIMENSIONS

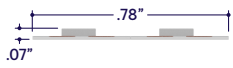

BEAM ANGLE

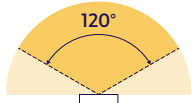

120° x 120° Beam

GENERAL FEATURES

Applications	Accent, Decorative, Surface, Recessed, Pendant Lighting
Viewing Angle	120°
Length	Built to Order (+/- 1/8" Tolerance)
Construction	Flexible LED Tape
Field Cutting	Dry Location Field Cuttable
Weight	0.016 lbs per foot
Mounting	Mounting Channel or Mounting Clips (Sold Separately)
Listing	Dry Location UL2108, 67.1.9, 60.4, CSA C22.2 #9 UL8750, CSA250
Temperature Ratings	Operating / Startup: -20° to 48°C (-4° to 120°F) Storage: -40° to 76°C (-40° to 170°F)
Installation Link	

ELECTRICAL

Dimming	DMX, DALI
Maximum Run (Class 1 Applications)	13' (9W) 16' (7.2W)
Maximum Run (Class 2 Applications)	9' (9W) 11' (7.2W)
Luminaire Voltage	24VDC

SPECIFY PRODUCT CODE | CHOOSE FROM DROP DOWNS

Series	Watts per Foot	Dimming	LED	Listing	Luminaire Length
A8-ZOMU-TAPE	9W		DWH	DRY	
ZOMU Tape (A8-ZOMU-TAPE)	9 Watts(9W) 927 Lumens / ft	DMX-512 ^{#1} (DMX) DALI ^{#2} (DALI)	Dynamic White: 2400K - 6400K (DWH)	Indoor (DRY)	Specify Length in Feet & Inches Example: 7'8"

^{#1} Default DMX address of each luminaire is 001. Consult third party DMX commissioner to modify at time of installation.

^{#2} DALI commissioning to be performed by a third party at time of installation. ALUZ does not provide DALI commissioning.



LAMP FEATURES

Lamp Type	Dynamic White LEDs: 2400K - 6400K
CRI	> 90

LAMP SPECIFICATIONS

Lamp Number	Correlated Color Temperature (CCT) Gamut	L70 LED Life
DWH	Dynamic White: 2400K - 6400K	50,000 hrs.

DRIVERS

Dimming Selection	Product Code	Link to Specification Sheet / URL
DMX-512	(DMX)	
DALI	(DALI)	

MOUNTING OPTIONS (Sold Separately)

Note: Mounting clips are only available in Natural Silver Finish, unless otherwise specified.

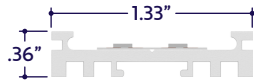

Part #	Qty.
A8-ZOMU-TAPE-UCW-8'	

Note: Order Mounting Channel as needed in 8', field cuttable segments. Click on image to see cut sheet for additional details.

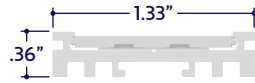

Part #	Qty.
A8-ZOMU-TAPE-UCW-CP	

Note: Use 1 Channel Clip every 6" for downward facing, outward facing, or vertically mounted applications.

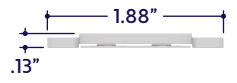

Part #	Qty.
A8-ZOMU-TAPE-MCS	

Note: Use 1 mounting clip per 6", rounded up. Click on image to see cut sheet for additional details.

DMX ACCESSORIES (Sold Separately)



Part #	Qty.
DRV100-E-UNV-24VDC-DMX-DRY-DWH	
DRV100-E-UNV-24VDC-DALI-DRY-DWH	

Note: Use 1 Driver for each run up to 100 Watts. Click on image to see Specification Submittal.



Part #	Qty.
CTRL-DMX-RGBX	

Note: Use 1 Decoder for each run up to 180 Watts. Not required if using DRV100-E.

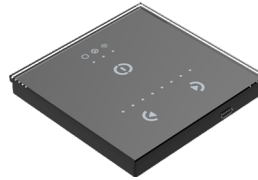

Part #	Qty.
CTRL-DMX-128C	

Note: Controls up to 128 DMX Channels, or up to 32 RGBW light fixtures.



Part #	Qty.
CTRL-DMX-1024C	

Note: Controls up to 1024 DMX Channels, or up to 256 RGBW light fixtures.

DRY CONNECTORS (Sold Separately)

Note: Connectors are factory assembled to each run length. Connectors are subject to change without notice.



Dry Power Connector
(20/3 Gauge Wire)
(A8-ZOMU-TAPE-PC-DRY-X)
X = Specify Length, 36" Default, 25' Maximum

Part #	Length	Qty.
A8-ZOMU-TAPE-PC-DRY-	36"	
A8-ZOMU-TAPE-PC-DRY-		

Note: Specify 1 Power Connector for each lead required. Power Connectors are factory assembled to each length.



Dry Power Connector with Black Jacket
(20/3 Gauge Wire)
(A8-ZOMU-TAPE-PC-DRY-BK-X)
X = Specify Length, 36" Default, 25' Maximum

Part #	Length	Qty.
A8-ZOMU-TAPE-PC-DRY-BK-	36"	
A8-ZOMU-TAPE-PC-DRY-BK-		

Note: Specify 1 Power Connector for each lead required. Power Connectors are factory assembled to each length.



Dry Power Connector with White Jacket
(20/3 Gauge Wire)
(A8-ZOMU-TAPE-PC-DRY-WH-X)
X = Specify Length, 36" Default, 25' Maximum

Part #	Length	Qty.
A8-ZOMU-TAPE-PC-DRY-WH-	36"	
A8-ZOMU-TAPE-PC-DRY-WH-		

Note: Specify 1 Power Connector for each lead required. Power Connectors are factory assembled to each length.

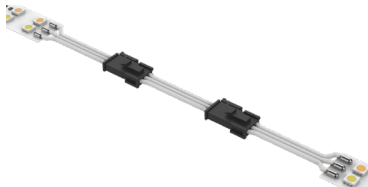

Dry Continuous Connector
(20/3 Gauge Wire)
(A8-ZOMU-TAPE-CC-DRY-X)
X = Specify Length, 3" Default

Part #	Length	Qty.
A8-ZOMU-TAPE-CC-DRY-	3"	
A8-ZOMU-TAPE-CC-DRY-		

Note: Specify Continuous Connectors to traverse a gap or obstacle. Continuous Connectors are factory assembled to specified lengths.



Dry Continuous Connector with Black Jacket
(20/3 Gauge Wire)
(A8-ZOMU-TAPE-CC-DRY-BK-X)
X = Specify Length, 3" Default

Part #	Length	Qty.
A8-ZOMU-TAPE-CC-DRY-BK-	3"	
A8-ZOMU-TAPE-CC-DRY-BK-		

Note: Specify Continuous Connectors to traverse a gap or obstacle. Continuous Connectors are factory assembled to specified lengths.

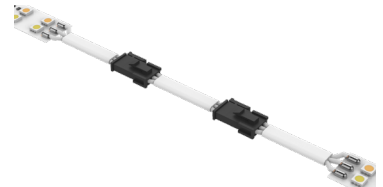

Dry Continuous Connector with White Jacket
(20/3 Gauge Wire)
(A8-ZOMU-TAPE-CC-DRY-WH-X)
X = Specify Length, 3" Default

Part #	Length	Qty.
A8-ZOMU-TAPE-CC-DRY-WH-	3"	
A8-ZOMU-TAPE-CC-DRY-WH-		

Note: Specify Continuous Connectors to traverse a gap or obstacle. Continuous Connectors are factory assembled to specified lengths.

SURFACE & CORNER MOUNT CHANNELS (Sold Separately)

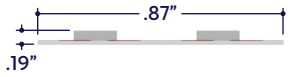

Material	Flexible Tape
Lens	None

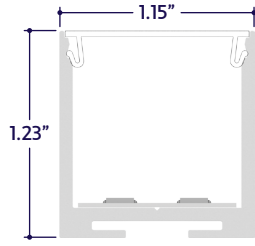

Material	Aluminum
Lens	Clear 50% Semi-Frosted 100% Frosted

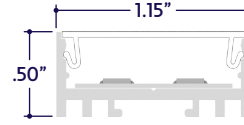

Material	Aluminum
Lens	Clear 50% Semi-Frosted 100% Frosted

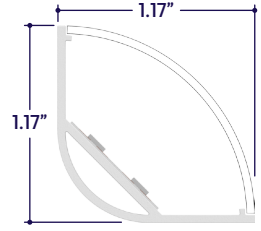

Material	Aluminum
Lens	Clear 50% Semi-Frosted 100% Frosted

RECESSED MOUNT CHANNELS (Sold Separately)

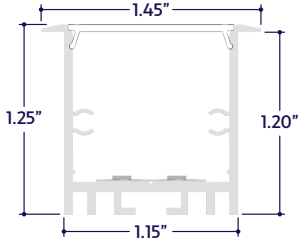

Material	Aluminum
Lens	Clear 50% Semi-Frosted 100% Frosted

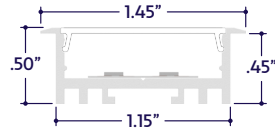

Material	Aluminum
Lens	Clear 50% Semi-Frosted 100% Frosted

DESIGN GUIDELINES

Individual Run (Dry Location)

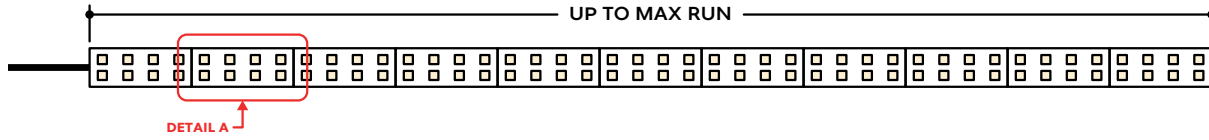

Run with Continuous Connector (Dry Location)

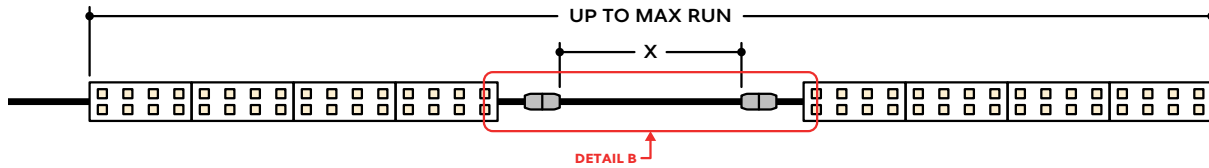

KEY

Detail A Dry Rated Tape: The LED tape is rated for indoor (Dry Location) applications only.

Detail B Dry Continuous Connector: Used to span a corner or traverse a gap, corner, or obstacle in a dry location installation area.

Note: Drawings not to scale. Product may differ from examples shown.

CONNECTION SEQUENCE



- Specifying a layout is not required to place an order.
- Configuration code applies to full length ordered and will be built per the Continuous Run models on Design Guidelines.
- Connector type subject to change based on availability and listing. Refer to Design Guidelines for details.

HOW TO SPECIFY CONFIGURATIONS

Example: 20' Straight Run

- 1x A8-ZOMU-TAPE-9W-DMX-DWH-DRY-20'-PC-EC

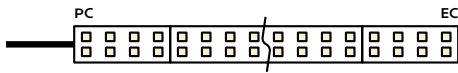

Example: 25' L-Shaped Run

- 1x A8-ZOMU-TAPE-9W-DMX-DWH-DRY-12'-PC-CC
- 1x A8-ZOMU-TAPE-9W-DMX-DWH-DRY-6'-CC-EC

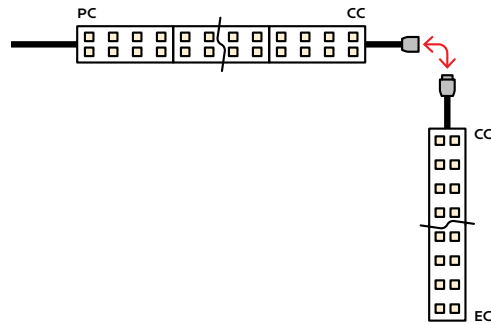

Example: 30' U-Shaped Run

- 1x A8-ZOMU-TAPE-9W-DMX-DWH-DRY-6'-PC-CC
- 1x A8-ZOMU-TAPE-9W-DMX-DWH-DRY-18'-CC-CC
- 1x A8-ZOMU-TAPE-9W-DMX-DWH-DRY-6'-CC-EC

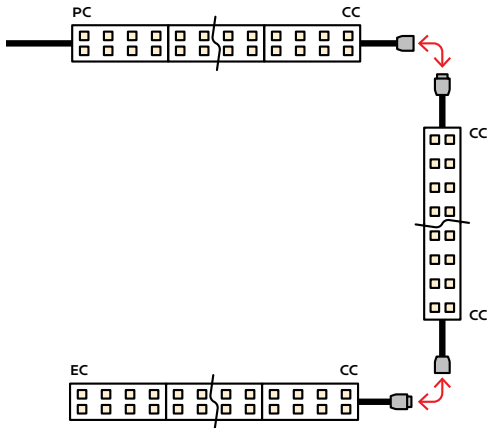

Example: 28' Rectangle Shaped Run

- 1x A8-ZOMU-TAPE-9W-DMX-DWH-DRY-11'-PC-CC
- 1x A8-ZOMU-TAPE-9W-DMX-DWH-DRY-3'-CC-CC
- 1x A8-ZOMU-TAPE-9W-DMX-DWH-DRY-11'-CC-CC
- 1x A8-ZOMU-TAPE-9W-DMX-DWH-DRY-3'-CC-EC

